

MAXXLEE

User Manual





Caution: Please read the user manual carefully and use the product correctly based on the user manual so that you can be familiar with the product more conveniently and quickly!

General Information

This product is capable of starting most 12V gasoline engines up to 8.0L Petrol and 6.0L Diesel, this includes 4 and 6 cylinder engines and inlines. It can also be additional power pack for your electronic devices. It has 1 car battery clamp socket (12V), 2 USB outputs (5V/ 2.1A), 1 DC5.5 output (12V, 16V, 19V) and a flashlight. With the LED display, you can read the status clearly and easily.

Technical Specifications

- Output voltage: 12V
- Peak capacity: 30000mAh
- Dimensions: 325×265×80mm
- Input charging ports: 6mm-15V, up to 1A/12V
Auto-12V, up to 1.5A
- Output ports: USB-5V 2.1A, 5V/2.1A
Auto jump starter- 12V
Electronic- 12/16/19V- 3.5A/3.5A/3.5A
- Charge mode: CC/CV 15V 1A
- Start Current: 400A
- Peak Current: 800A
- Cycle life: 3000 cycles @ 80 depth of discharge
- Application temperature range: -20°C to +60°C. Cell performance may degrade at low temperature.
- Charging times- Wall Charger: 3 - 4 hours

Safety Information

Please read this entire manual before attempting to use the product.

Warning

1. Do not damage, drop or crush this item. Do not attempt to use this item or battery charger that has been dropped, punctured, run over or damaged in any way.
2. Do not charge this item in wet conditions (rain, snow, damp). Do not use this product in explosive environments (dust, gaseous flumes, or flammable materials).
3. Do not burn or incinerate this product. It may explode, causing personal injury or damage. Toxic fumes and other potentially harmful materials are created when the battery is burned.
4. Do not disassemble this product. It may result in risk of fire, electric shock or exposure to battery chemicals.
5. Do not insert foreign objects into ANY input or output ports. This item may short circuit. Any metal that comes in contact with the jumper cable port may short circuit. Short circuiting this product will damage the battery and may cause personal injury or fire.
6. This is a Lithium ion battery. In the unlikely event that this product leaks battery chemicals, do not allow contact with skin, eyes or mouth as it may cause personal injury or burns. If skin is exposed to battery chemicals, wash with soap and water and rinse with vinegar. If your eyes come in contact with battery chemicals, immediately flush with water and then see a medical professional.
7. When recharging this item, make sure the area is well ventilated. Please do not smoke or allow open flames near a charging battery.
8. Never jump start a frozen battery.
9. Never reversely connect the red & black clamps when the original car battery has been removed, or the car might be compromised.
10. Please keep the product away from and out of reach of children.
11. Store this unit in a cool dry location. Do not expose the product to temperatures over 70°C or below -30°C.

IV Product Features

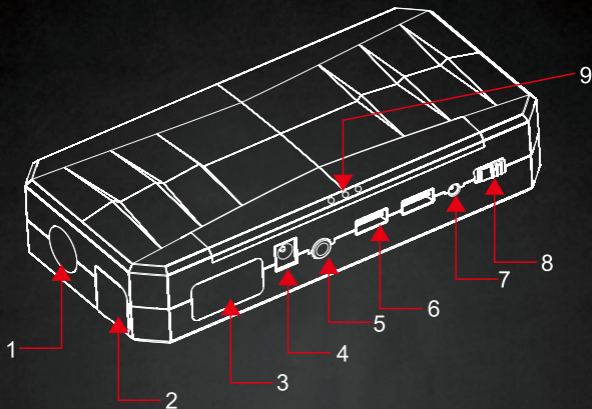

1. Flashlight
2. Battery terminal socket for the car start
3. LED display
4. 12/16/19V-3.5A/3.5A/3.5A Outlet
5. Push button
6. 5V-2.1A Output
7. 15V/1A Input
8. Power ON/OFF
9. Emergency malfunctioning indicator

V Package Contents



Function on Smart Battery Cable (Optional)

- 1) Reverse polarity connection: Solid Red LED with fast 2 short beep.
- 2) Short-circuit protection: Solid Red LED with long beep (Beeping as 3.3Hz Frequency).
- 3) Over-heat protection: Solid red LED with Long beep (Beeping as 2Hz Frequency).
- 4) Over-discharging protection: Solid red LED with fast 2 short beep.
- 5) Green/Red LED flashing: Searching for status of connection.
- 6) Green Led: Correct connection after one beep

1. Jump Starting Vehicles

Before attempting to jump start your vehicle, please read your vehicle owners manual to insure there are no specific steps needed.

DO NOT crank the engine for more than 4 continuous seconds while the unit is connected to the battery. If the engine fails to crank or start, there may be a problem other than a discharged battery.

1st step:

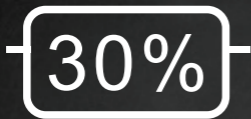

Make sure $\geq 30\%$ power

2nd step:

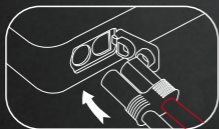

Insert the battery clamp to jump starter

5th step:

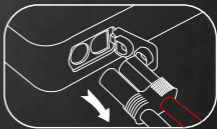

Remove the battery clamp from the jump starter and car battery

3rd step:

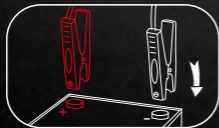

Connect red clamp with "+" of car battery, black clamp with "-"

4th step:



Car Start up

2. Charging Electronic Devices

(1) For Cell Phones/Tablets

1st step:



Choose a suitable cell phone connector

2nd step:



Insert the USB charging line into 5V/2.1A output of the jump starter

3rd step:



Insert the other side of charging cable into cell phone table inlet

4th step:



Switch to "ON", afterwards short press  then your device is under charging

(2) For Laptops

1st step:



Choose the suitable connector to your laptop

2nd step:



Insert the laptop charging cable into laptop outlet of the jump starter

3rd step:



Insert the other end of the laptop charging line into your laptop

4th step:



Switch to "ON", afterwards short press  then your device is under charging

(3) For PSP

See the steps in “ for Cell phones/Tablets”

(4) For Digital Cameras/DVD

See the steps in “ for Cell phones/Tablets”

3. Self-charging

1st step:



Choose the matched home adapter

2nd step:

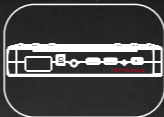

Insert  into 15V/1A input of the jump starter



3rd step:



Plug  into household 220V/110V socket, then it's under charging when indication light flickers

4. Flashlight Operation

(1) Emergency Light

Double press  to activate the emergency light, double press  again to shut it off



(2) Flashlight

Press and hold  for 3 seconds to start flashlight Press  again to shift to SOS, flashing Press  again to turn off the flashlight

VII Trouble Shooting

Problem	Cause	Solution
No response when pressing the push button	Low voltage protection of jump start is activated	Charge the unit with home charger or car charger to deactivate the protection
Jump start shuts down automatically when charging multiple electronics devices at the same time	Over current protection of jump start is activated	Charge the electronic devices separately with different USB outlets, but please keep the total output current within 3.5A

VIII Toxic & Harmful Substances

Composition and amount of toxic & harmful substances in Car Jump Starter					
Pb	Hg	Cd	Cr(VI)	PBB	PBDE
○	○	○	○	○	○

○ :indicating all homogeneous materials' hazardous substances are below the MCV limit specified in the Standard 2002/95/EC(RoHs)

IX Warranty Information

1. Warranty Terms

◎ We offer a limited warranty for this product against any defects in material and workmanship for a period of 12 months from the date of purchase by the end user/consumer. The conditions of the warranty are as follows:

◎ The warranty is only valid upon presentation of the original receipt (from dealer/retailer) by the original purchaser with the product to be repaired or replaced

◎ The warranty is void if the serial number, date of purchase and label has been removed

◎ The warranty does not cover damage or product failure resulting from normal wear and tear, physical abuse, improper installation, misuse, modification or repairs by unauthorized third parties

◎ We do not assume responsibility for any loss or damage incurred during shipment or as a result of a force majeure

◎ We are not liable for any incidental or consequential damages arising from the use or misuse of this product

◎ All warranty claims are limited to repair or replacement of the defective product and at the sole discretion of us

◎ If we repair or replace the product, the product will be covered for the remaining time of the original warranty period. Repair or replacement may involve the use of reconditioned units which are equivalent in function. Replaced part or product becomes the property of us.

◎ Consumable components such as batteries are not covered by the warranty

Warranty Card

Warranty Card

ONE YEAR LIMITED WARRANTY

Model		Serial NO.	
Purchase Date		Maintenance Date	
Customer Name		Tel	
Address			
Seller			

Description of Product Anomalies

Large empty rectangular area for describing product anomalies.

Caution: please read the user manual carefully

Multifunctional Emergency Jump starter

